

ROTARY PADDLE TYPE LEVEL SWITCH

NL/NM/FL-GM/NNL/NNM SERIES

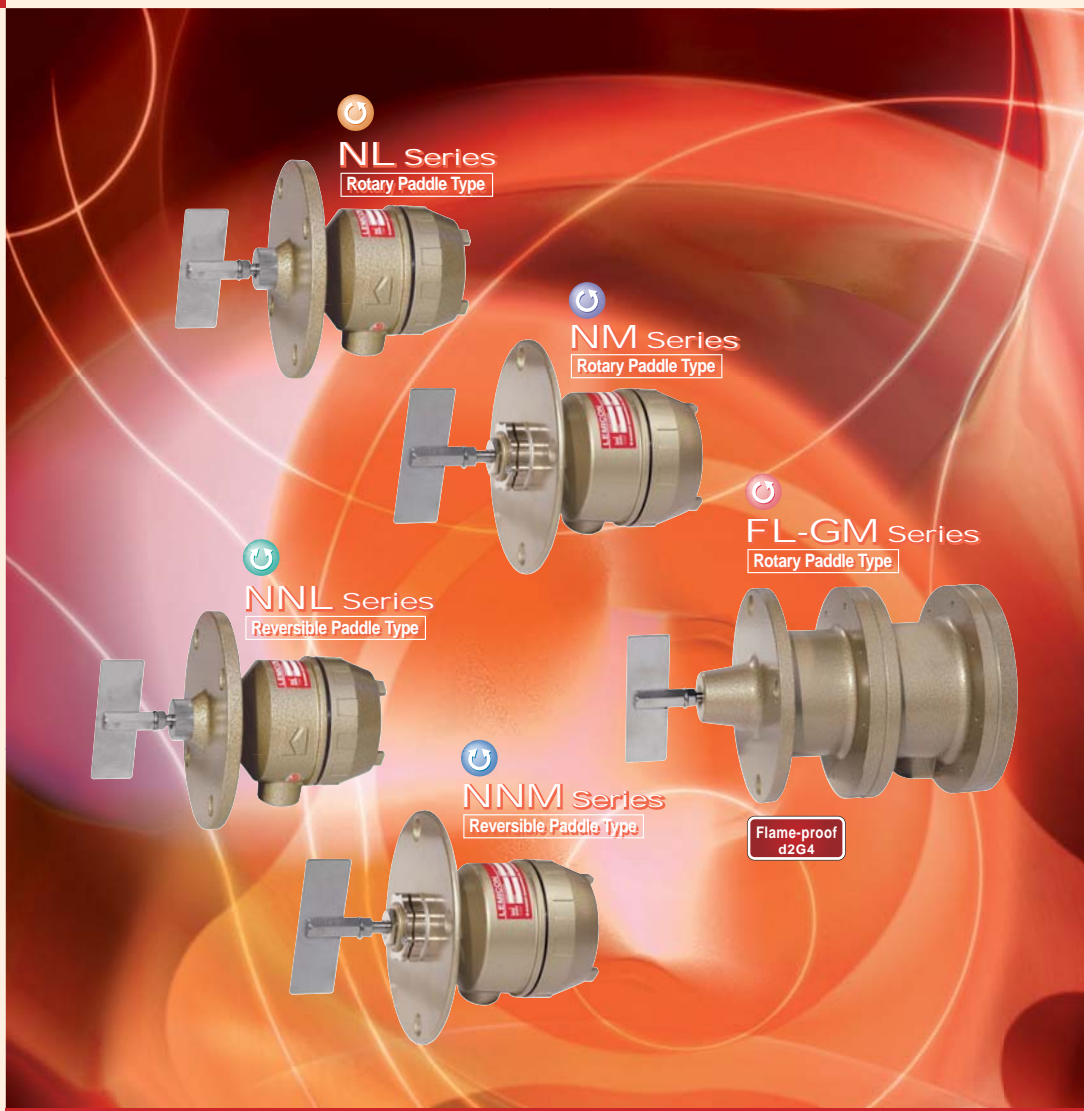

Uncomparable models developed based on our abundant technology experiences and long-term achievements in the market. A variety of products are lined up. We assure that you will be able to find an optimum model

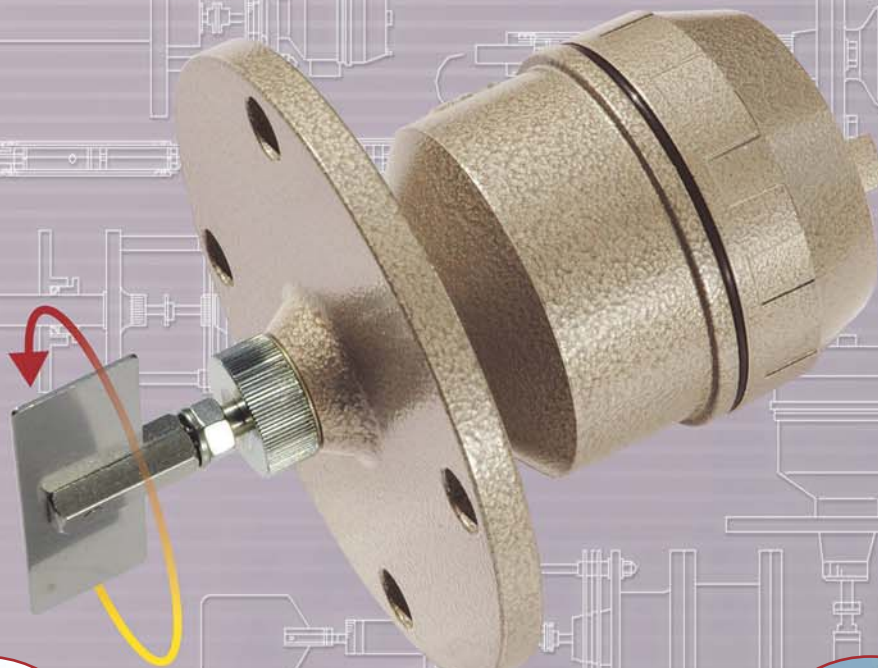

ROTARY PADDLE TYPE LEVEL SWITCH

Level Switch you can use in versatile applications, exclusively for powders.

As it is easy to handle, it operates stably for an extended period. It is the best selling line for having gained customers' confidence and expanded its sales record in the market.



NL Series
Standard type for detecting powder, versatile usages.

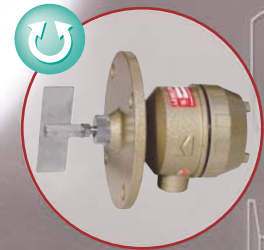

NNL Series
The original switching system enables the amazing long life of the motor.



NM Series
Cost effective, standard type with no excessive functions.

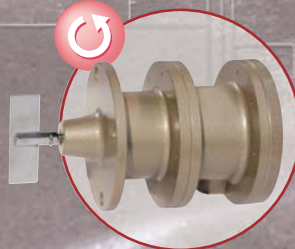

FL-GM Series
Various models of Explosion-proof Type.



NNM Series
Reversible Type, Highly cost effective.

Flame-proof
d2G4

A standard model of rotary type level switch that continuously keeps evolving.
Covering a wide range of applications with various models.

Rotary Paddle Type
NL/NM
Series

- You may easily adjust torque when taking off the Lid.
- Oil seal and thrust Teflon packing prevent powder from entering the shaft.
- The clutch system helps prevent the motor from being broken even when the paddle is overloaded.

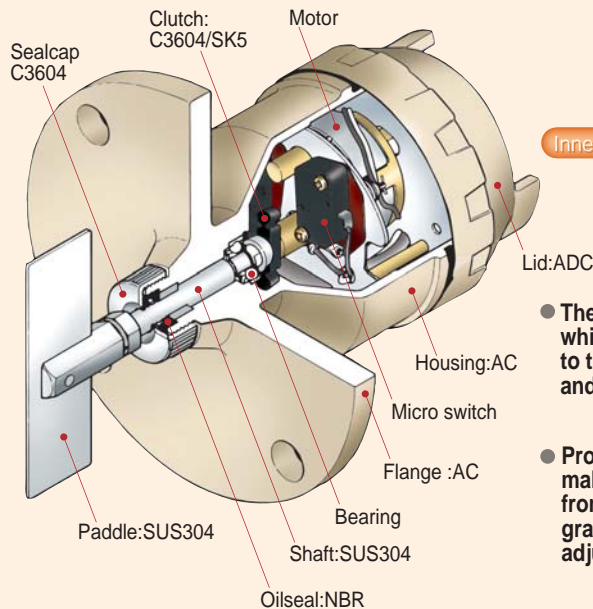

Inner Structure

- The internal unit can be removed while the main body is attached to the tank, making inspection and maintenance easy.
- Properly selecting the paddle size makes stable detection possible from low density power to granular material without adjusting the sensitivity.

Principle Of Operation

A rotating paddle, being loaded by materials in a tank, activates a limit switch and brings contact output and motor rotation to a halt at the same time. With no load by materials, the motor resumes rotation. A clutch system prevents the motor from breaking by letting out excessive load and shock when the paddle is overloaded or suffers a strong shock.

Standard Specification

- Power Source** : 100–110VAC or 200–220VAC 50/60Hz
- Power Consumption** : 4W
- Contact Capacity** : 250VAC 5A Resistance Load
- Rate of Rotation** : 1r.p.m/50Hz
- Allowable Temperature** : Environment 0-50°C
(Specs for cold location is available)
In tank 0-50°C
Heat resistant type NL series Max250°C
NM series Max180°C
- Withstand Voltage** : 1500VAC one minute for in between terminal and housing
- Detection Torque** : $1470-1764N \cdot m \times 10^{-4}$
- Allowable Pressure** : 19.6kPa
Color : Gold
- Process Connection** : G1B or Equivalent to JIS 5K 65A
- Enclosure Rating** : IP65

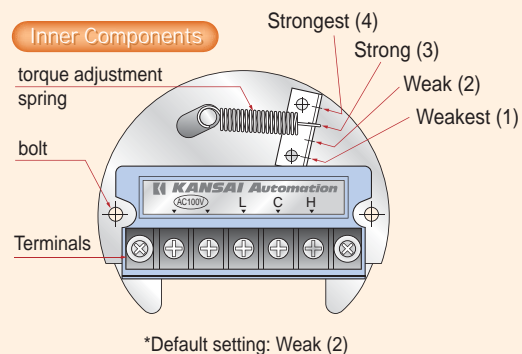

*Default setting: Weak (2)

Wiring Diagram

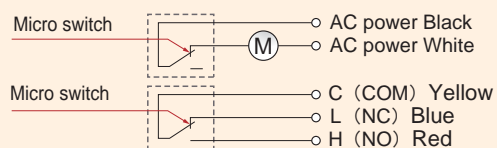

* Wiring of NL-8DA is determined by the color of the cable as shown above.

24VDC Power Adaptive

An AC motor model has had an excellent sales record for a long period of time since the introduction into the market, and it, its electromechanical components remaining unremoved, is replaced with DC motor, which makes Rotary Type Level Switch of DC type, featured by stable and reliable rotations. Because the electronic components are surface mounted, vibration resistance is upgraded.

Standard Specification

- Power Source** : 24VDC ±1V
- Power Consumption** : 5W
- Contact Capacity** : 30VDC 100mA Resistance Load
- Rate of Rotation** : 1.25r.p.m

* Allowable temperature and pressure, detection torque and so on are the same as those of NL & NM.

Wiring Diagram

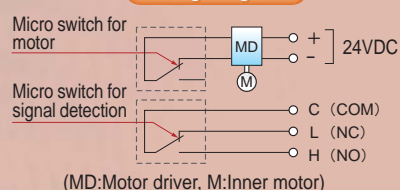

ROTARY PADDLE TYPE LEVEL SWITCH

Rotary Paddle Type
model **NL**

The basic model of rotary type level switch that can be applied to all conditions

(Wetted parts can be made of SUS304 or SUS316)

Standard Flange Type **NL-8B**

The NL basic model, suitable for powders not much sticking to the tank wall.

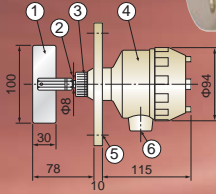
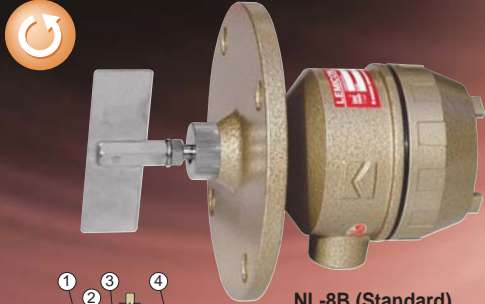

NL-8B (Standard)

| | | |
|---|--------------------|--------|
| 1 | Paddle | SUS304 |
| 2 | Main Shaft | SUS304 |
| 3 | Sealcap | C3604 |
| 4 | Housing | AC |
| 5 | Flange | AC |
| 6 | Conduit Connection | G 1/2 |

- Flange size: JIS5K65A equivalent
- L Dimension below flange can be extended up to 200mm.
- Weight: about 1.65kg

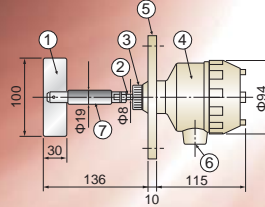

NL-8BF (Flexible shaft)

| | | |
|---|--------------------|--------|
| 1 | Paddle | SUS304 |
| 2 | Main Shaft | SUS304 |
| 3 | Sealcap | C3604 |
| 4 | Housing | AC |
| 5 | Flange | AC |
| 6 | Conduit Connection | G 1/2 |
| 7 | Flexible Shaft | — |

- Flange size: JIS5K65A equivalent

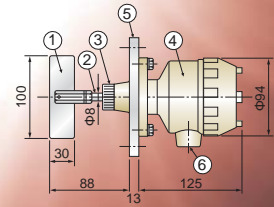
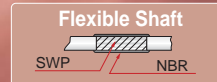

NL-8B (Wetted part SUS)

| | | |
|---|--------------------|--------|
| 1 | Paddle | SUS304 |
| 2 | Main Shaft | SUS304 |
| 3 | Sealcap | SUS304 |
| 4 | Housing | AC |
| 5 | Flange | SUS304 |
| 6 | Conduit Connection | G 1/2 |

- Flange size: JIS5K65A equivalent

Adjustable Shaft Type **NL-8BA**

The shaft can be adjustable to the selective length with fixing nuts. Even if the angle of repose is unknown, it can be optimally adjusted on site.

*Upper Limit detection type

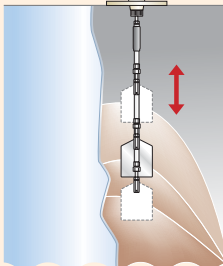
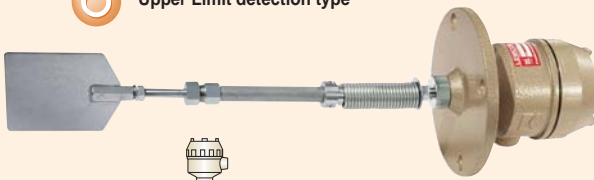

- Flange Size: JIS5K65A equivalent
- Vertical mounting
- The shaft is protected with a universal joint.
- The shaft can be adjustable to the selective length with fixing nuts.
- Heat resistant type can be available.

NL-8BA (Reinforcing spring)

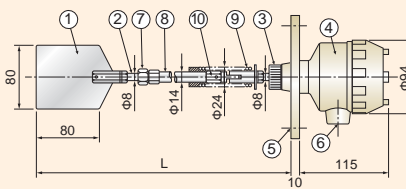

| | | |
|----|--------------------|--------|
| 1 | Paddle | SUS304 |
| 2 | Main Shaft | SUS304 |
| 3 | Sealcap | C3604 |
| 4 | Housing | AC |
| 5 | Flange | AC |
| 6 | Conduit Connection | G 1/2 |
| 7 | Lock Nut | C3604 |
| 8 | Protective Tube | SGP |
| 9 | Spring | SWP |
| 10 | Universal Joint | SS400 |

- Weight: about 2.2kg (Max.L=1000)

NL-8BA (Reinforcing rubber)

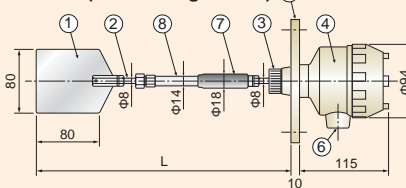

| | | |
|---|--------------------|--------|
| 1 | Paddle | SUS304 |
| 2 | Main Shaft | SUS304 |
| 3 | Sealcap | C3604 |
| 4 | Housing | AC |
| 5 | Flange | AC |
| 6 | Conduit Connection | G 1/2 |
| 7 | Spring | NBR |
| 8 | Universal Joint | SS400 |
| 9 | Protective Tube | SGP |

- Weight: about 2.2kg (Max.L=1000)

Protective-tube extension type **NL-8BS**

When the angle of repose is greater, there is much build-up on the tank-wall and so on, vertical, horizontal and diagonal mounting can be selected.

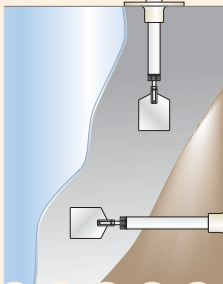
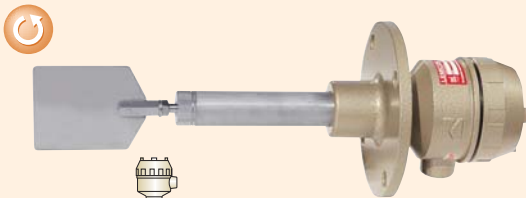

- Flange Size: JIS5K65A equivalent
- Main shaft is protected with protective tube.
- The L dimensions below flange can be made available from over 200mm.
- Sliding flange of the gland packing type can be manufactured.
- Heat resistant type can be available.

NL-8BS (Protective tube extension)

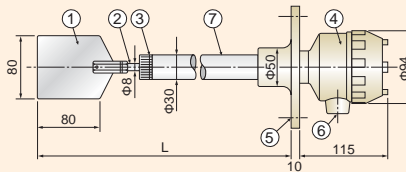

| | | |
|---|--------------------|--------|
| 1 | Paddle | SUS304 |
| 2 | Main Shaft | SUS304 |
| 3 | Sealcap | C3604 |
| 4 | Housing | AC |
| 5 | Flange | AC |
| 6 | Conduit Connection | G 1/2 |
| 7 | Protective Tube | SUS304 |

- Weight: about 2.0kg (L=200)

NL-8BS (L is adjustable by sliding flange)

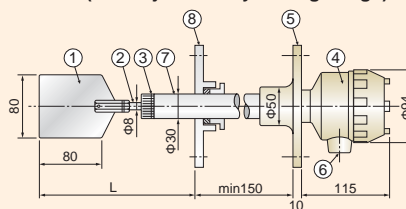

| | | |
|---|--------------------|--------|
| 1 | Paddle | SUS304 |
| 2 | Main Shaft | SUS304 |
| 3 | Sealcap | C3604 |
| 4 | Housing | AC |
| 5 | Flange | AC |
| 6 | Conduit Connection | G 1/2 |
| 7 | Protective Tube | SUS304 |
| 8 | Sliding Flange | SS400 |

Heat Resistant Type

NL-8BH

Operating temperature in a tank: 250°C. Optional air or water cooled type can operate at a higher temperature.

●Flange size: JIS5K65A equivalent



NL-8BH (Standard)

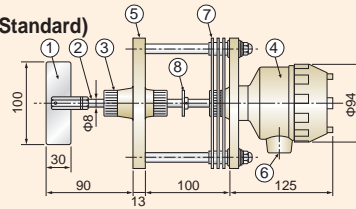

| | | |
|---|----------------------|--------|
| 1 | Paddle | SUS304 |
| 2 | Main Shaft | SUS304 |
| 3 | Sealcap | C3604 |
| 4 | Housing | AC |
| 5 | Flange | SS400 |
| 6 | Conduit Connection | G 1/2 |
| 7 | Radiation Fin | ALP |
| 8 | Rotation Check Board | AC |

●Weight: about 4.4kg

NL-8BHA (Shaft-length Adjustable Type)

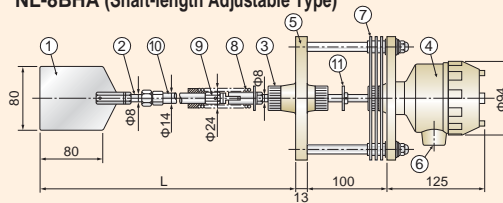

| | | |
|----|----------------------|--------|
| 1 | Paddle | SUS304 |
| 2 | Main Shaft | SUS304 |
| 3 | Sealcap | C3604 |
| 4 | Housing | AC |
| 5 | Flange | SS400 |
| 6 | Conduit Connection | G 1/2 |
| 7 | Radiation Fin | ALP |
| 8 | Spring | SWP |
| 9 | Universal Joint | SS400 |
| 10 | Protective Tube | SGP |
| 11 | Rotation Check Board | AC |

NL-8BHS (Protective Tube Extension Type)

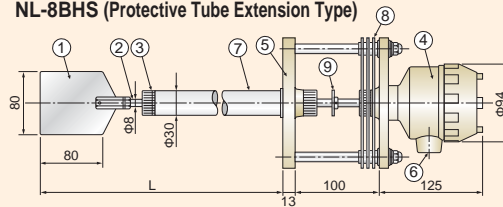

| | | |
|---|----------------------|--------|
| 1 | Paddle | SUS304 |
| 2 | Main Shaft | SUS304 |
| 3 | Sealcap | C3604 |
| 4 | Housing | AC |
| 5 | Flange | SS400 |
| 6 | Conduit Connection | G 1/2 |
| 7 | Protective Tube | SUS304 |
| 8 | Radiation Fin | ALP |
| 9 | Rotation Check Board | AC |

Withstand Load Type

NL-15B

Lower limit detection of a large tank. Level switch of withstanding load type mounted in a lower part of a silo. Both heat-resistant and protective tube extension types can be manufactured.

●Flange size: JIS5K65A equivalent



NL-15BS (Protective Tube Extension Type)

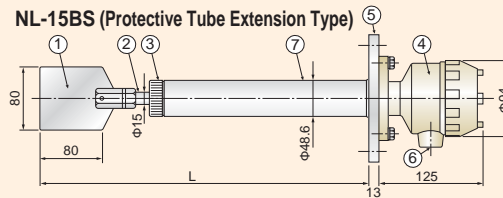

| | | |
|---|--------------------|--------|
| 1 | Paddle | SUS304 |
| 2 | Main Shaft | SUS304 |
| 3 | Sealcap | C3604 |
| 4 | Housing | AC |
| 5 | Flange | SS400 |
| 6 | Conduit Connection | G 1/2 |
| 7 | Protective Tube | SUS304 |

NL-15B (Standard)

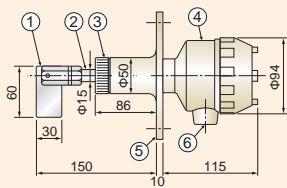

| | | |
|---|--------------------|--------|
| 1 | Paddle | SUS304 |
| 2 | Main Shaft | SUS304 |
| 3 | Sealcap | C3604 |
| 4 | Housing | AC |
| 5 | Flange | AC |
| 6 | Conduit Connection | G 1/2 |

●Weight: about 2.2kg

NL-15BH (Heat resistant)

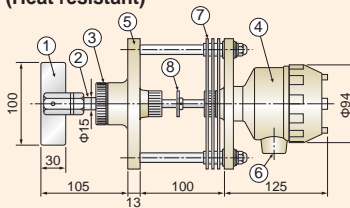

| | | |
|---|----------------------|--------|
| 1 | Paddle | SUS304 |
| 2 | Main Shaft | SUS304 |
| 3 | Sealcap | C3604 |
| 4 | Housing | AC |
| 5 | Flange | SS400 |
| 6 | Conduit Connection | G 1/2 |
| 7 | Radiation Fin | ALP |
| 8 | Rotation Check Board | AC |

NL-15BY (Protective cover)

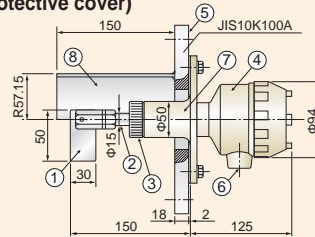

| | | |
|---|--------------------|--------|
| 1 | Paddle | SUS304 |
| 2 | Main Shaft | SUS304 |
| 3 | Sealcap | C3604 |
| 4 | Housing | AC |
| 5 | Flange | SS400 |
| 6 | Conduit Connection | G 1/2 |
| 7 | Boss | AC |
| 8 | Protective Cover | SGP |

Inner Tank Hanging Type

NL-8DA

Suspended in a tank with 40A pipe. It can be used under varied conditions.

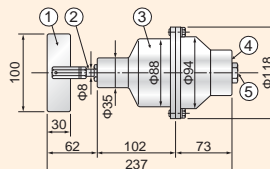
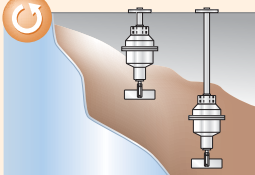

| | | |
|---|--------------------|--------|
| 1 | Paddle | SUS304 |
| 2 | Main Shaft | SUS304 |
| 3 | Housing | AC |
| 4 | Mounting Screw | G1-1/2 |
| 5 | Conduit Connection | G 1/2 |

●Suspend it in a tank with 40A pipe.
 ●Advise us of the length of lead cable. (Standard 350mm)
 ●Weight: about 1.3kg

ROTARY PADDLE TYPE LEVEL SWITCH

Rotary Paddle Type
model **NM**

Complete standardization of parts makes it an affordable price.

(Wetted parts can be made of SUS304 or SUS316)



Standard Flange Type **NM-8B** Basic Model of NM

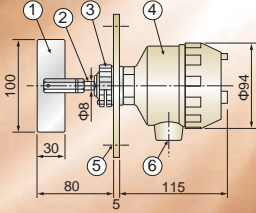

| | | |
|---|--------------------|--------|
| 1 | Paddle | SUS304 |
| 2 | Main Shaft | SUS304 |
| 3 | Nut | ADC |
| 4 | Housing | ADC |
| 5 | Flange | SS400 |
| 6 | Conduit Connection | G 1/2 |

- Flange size: JIS5K65A equivalent
- Flange of non-standard size can be manufactured (Over JIS5K65A).
- It will be G1B connection if the flange is removed.
- Weight: about 1.65kg

Screwed Joint Type **NM-SC** Small Hopper Level Switch

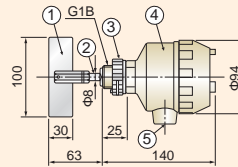

| | | |
|---|--------------------|--------|
| 1 | Paddle | SUS304 |
| 2 | Main Shaft | SUS304 |
| 3 | Nut | ADC |
| 4 | Housing | ADC |
| 5 | Conduit Connection | G 1/2 |

- Mounting G1B
- Weight: about 1.1kg
- *Make the tank diameter $\Phi 34$ in mounting NM-SC.
- *The outside diameter of the crown nut is $\Phi 48$

Adjustable Shaft Type **NM-8BA** Vertical Mounting

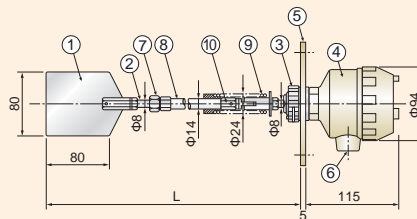

| | | |
|----|--------------------|--------|
| 1 | Paddle | SUS304 |
| 2 | Main Shaft | SUS304 |
| 3 | Nut | ADC |
| 4 | Housing | ADC |
| 5 | Flange | SS400 |
| 6 | Conduit Connection | G 1/2 |
| 7 | Lock Nut | C3604 |
| 8 | Protective Tube | SGP |
| 9 | Spring | SWP |
| 10 | Universal Joint | SS400 |

- Flange size: JIS5K65A equivalent
- Heat resistant type can be available.
- Weight: about 2.0kg (L=Max.500)

Protective-tube extension type **NM-8BS** Adjust the L dimensions by sliding flange

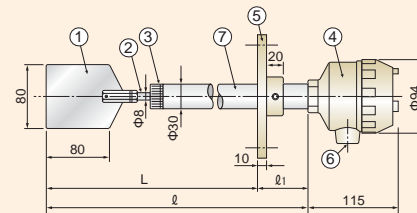
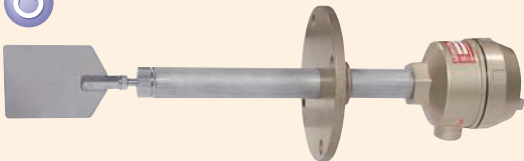

| | | |
|---|--------------------|--------|
| 1 | Paddle | SUS304 |
| 2 | Main Shaft | SUS304 |
| 3 | Sealcap | C3604 |
| 4 | Housing | ADC |
| 5 | Flange | AC |
| 6 | Conduit Connection | G 1/2 |
| 7 | Protective Tube | SUS304 |

- The L dimensions below the flange can be made from over 200mm.
- Heat resistant type can be available.
- Weight: about 2.2kg (L=200)

Heat Resistant Type **NM-8BH** Operating temperature in a tank: below 180°C

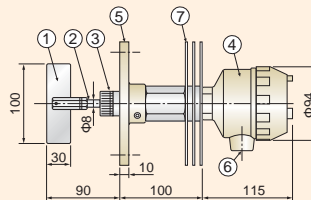
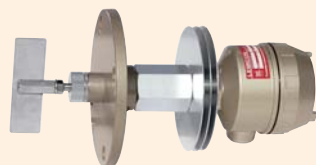

The mechanical consumable parts inside the motor are removed by a unique mechanism to achieve long life and stability that cannot be achieved with a standard rotary level switch!

Reversible Paddle Type

NNL/NNM Series

Highly effective in the processes where it frequently switches ON/OFF.

Materials is always flowing in the tank.

Because of small tank the powder is charged and discharged very fast.

These processes frequently require the level switch's detecting operations, thus extremely shortening the motor's life. These series, however, secure the long life of the motor unit.

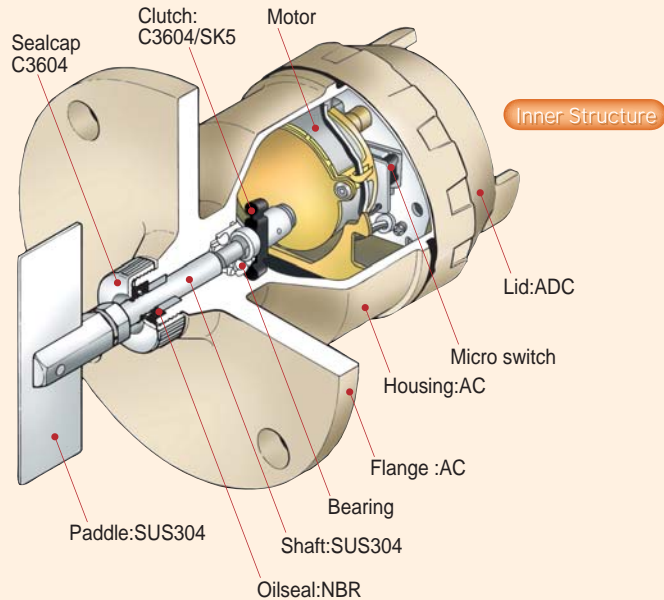

Principle Of Operation

Utilizing the switching system we developed based on our experiences and accomplishments in the market has offered a highly stable and reliable detection regardless of its rotating paddle direction.

A rotating paddle being loaded by materials in a tank activates a micro switch and brings contact output and motor rotation to a halt at the same time.

With no load by materials, the motor resumes rotation.

When the paddle is overloaded or suffers strong shock, a clutch system prevents the engine from being broken by letting out excessive load and shock.



Standard Specification

- Power Source** : 100-110VAC or 200-220VAC 50/60Hz
- Power Consumption** : 4W
- Contact Capacity** : 250VAC 3A Resistance Load
- Rate of Rotation** : 1 r.p.m./50Hz
- Allowable Temperature** : Environment 0-50°C
(Specs for cold location is available.)
In tank 0-50°C
Heat resistant type NNL series Max250°C
NNM series Max180°C
- Withstand Voltage** : 1500VAC one minute for in between terminal and housing
- Detection Torque** : about 1000-2800N · m × 10⁻⁴
- Allowable Pressure** : 19.6kPa
- Color** : Gold
- Process Connection** : G1B or Equivalent to JIS 5K 65A
- Enclosure Rating** : IP65

Inner Components

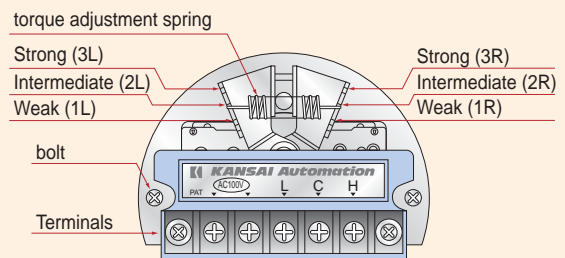

Wiring Diagram

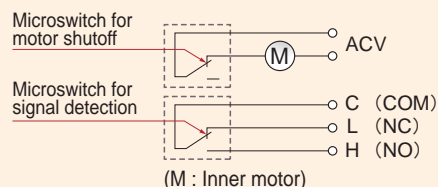

Reversible Paddle Type
model **NNL**

Basic model of reversible rotary paddle type
with long life and high stability.

(Wetted parts can be made
of SUS304 or SUS316)

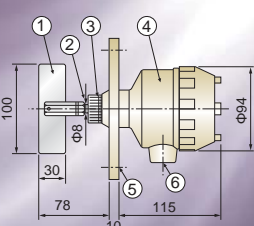



| | | |
|---|--------------------|--------|
| 1 | Paddle | SUS304 |
| 2 | Shaft | SUS304 |
| 3 | Sealcap | C3604 |
| 4 | Housing | AC |
| 5 | Flange | AC |
| 6 | Conduit Connection | G 1/2 |

- Flange size: JIS5K65A equivalent
- The L dimensions below flange can be extended up to 200mm.
- Weight: about 1.65kg

Standard Flange Type **NNL-8B** Basic model of MNL

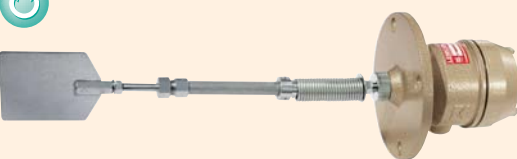
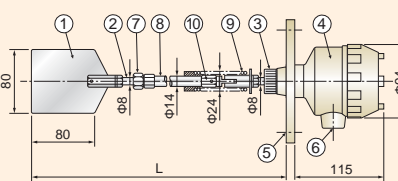
Adjustable Shaft Type **NNL-8BA** Vertical mounting

| | | |
|----|--------------------|--------|
| 1 | Paddle | SUS304 |
| 2 | Main Shaft | SUS304 |
| 3 | Sealcap | C3604 |
| 4 | Housing | AC |
| 5 | Flange | AC |
| 6 | Conduit Connection | G 1/2 |
| 7 | Lock Nut | C3604 |
| 8 | Protective Tube | SGP |
| 9 | Spring | SWP |
| 10 | Universal Joint | SS400 |

- Flange size: JIS5K65A equivalent
- Heat resistant type can be manufactured.
- Weight: about 2.2kg (L= Max1000)

Protective-tube extension type **NNL-8BS** When the angle of repose is greater, there is much build-up on the tank-wall and so on, vertical, horizontal and diagonal mounting can be selected.

| | | |
|---|--------------------|--------|
| 1 | Paddle | SUS304 |
| 2 | Main Shaft | SUS304 |
| 3 | Sealcap | C3604 |
| 4 | Housing | AC |
| 5 | Flange | AC |
| 6 | Conduit Connection | G 1/2 |
| 7 | Protective Tube | SUS304 |

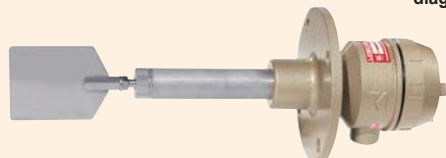
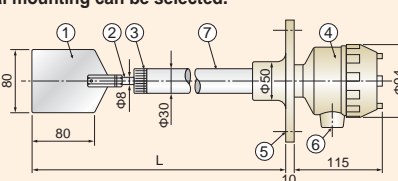
- Flange size: JIS5K65A equivalent
- The L dimensions below flange can be made from over 200mm.
- Sliding flange of the gland packing type can be manufactured.
- Heat resistant type can be available.
- Weight: about 2.0kg (L=200)

Heat Resistant Type **NNL-8BH** Operating temperature in a tank: below 250°C

| | | |
|---|----------------------|--------|
| 1 | Paddle | SUS304 |
| 2 | Main Shaft | SUS304 |
| 3 | Sealcap | C3604 |
| 4 | Housing | AC |
| 5 | Flange | SS400 |
| 6 | Conduit Connection | G 1/2 |
| 7 | Radiation Fin | ALP |
| 8 | Rotation Check Board | AC |

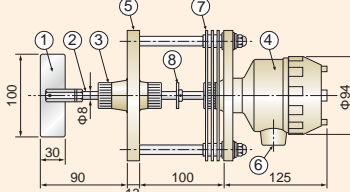
- Flange size: JIS5K65A equivalent
- Special version of max 1000°C
- Both Shaft-length adjustable and protective tube extension types can be available.
- Weight: about 4.4kg

Withstand Load Type **NNL-15B** Level switch of withstanding load type mounted in a lower part of a silo.

| | | |
|---|--------------------|--------|
| 1 | Paddle | SUS304 |
| 2 | Main Shaft | SUS304 |
| 3 | Sealcap | C3604 |
| 4 | Housing | AC |
| 5 | Flange | AC |
| 6 | Conduit Connection | G 1/2 |

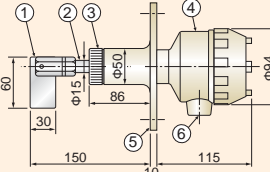
- Flange size: JIS5K65A equivalent
- Heat resistant type and protective tube extension type can be available.
- Weight: about 2.2kg

Inner Tank Hanging Type **NNL-8DA** Suspended in a tank with 40A pipe.

| | | |
|---|--------------------|--------|
| 1 | Paddle | SUS304 |
| 2 | Main Shaft | SUS304 |
| 3 | Housing | AC |
| 4 | Mounting Screw | G1-1/2 |
| 5 | Conduit Connection | G 1/2 |

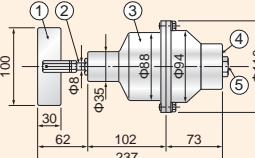
- Advise us of the length of lead cable. (Standard 350mm)
- Weight: about 1.3kg

ROTARY PADDLE TYPE LEVEL SWITCH

Reversible Paddle Type
model **NNM**

Affordable price model of Reversible
Rotary Paddle Type

(Wetted parts can be
made of SUS304 or SUS316)



Standard Flange Type **NNM-8B** Basic Model of NNM

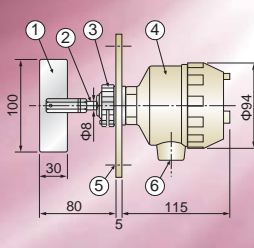

| | | |
|---|--------------------|--------|
| 1 | Paddle | SUS304 |
| 2 | Main Shaft | SUS304 |
| 3 | Nut | ADC |
| 4 | Housing | ADC |
| 5 | Flange | SS400 |
| 6 | Conduit Connection | G 1/2 |

- Flange size: JIS5K65A equivalent
- Flange of non-standard size can be manufactured (Over JIS5K65A).
- It will be G1B connection if the flange is removed.
- Weight: about 1.65kg

Screwed Joint Type **NNM-SC** Small Hopper Level Switch

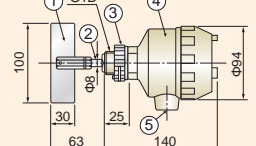
| | | |
|---|--------------------|--------|
| 1 | Paddle | SUS304 |
| 2 | Main Shaft | SUS304 |
| 3 | Nut | ADC |
| 4 | Housing | ADC |
| 5 | Conduit Connection | G 1/2 |

- Mounting G1B
- Weight: about 1.1kg
- * Make the tank diameter $\Phi 34$ in mounting NNM-SC.
- * The outside diameter of the crown nut is $\Phi 48$.

Adjustable Shaft Type **NNM-8BA** Vertical Mounting

| | | |
|----|--------------------|--------|
| 1 | Paddle | SUS304 |
| 2 | Main Shaft | SUS304 |
| 3 | Nut | ADC |
| 4 | Housing | ADC |
| 5 | Flange | SS400 |
| 6 | Conduit Connection | G 1/2 |
| 7 | Lock Nut | C3604 |
| 8 | Protective Tube | SGP |
| 9 | Spring | SWP |
| 10 | Universal Joint | SS400 |

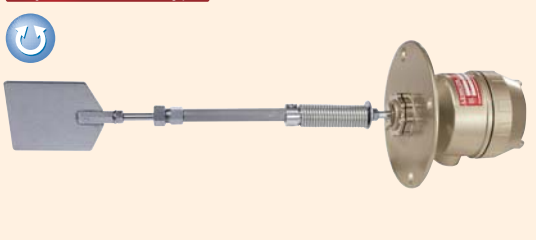
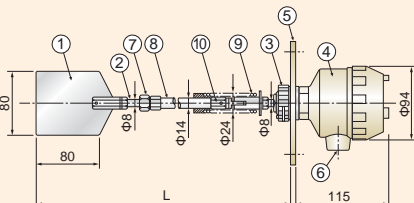
- Flange size: JIS5K65A equivalent
- Heat resistant type can be available.
- Weight: about 2.0kg (L=Max.500)

Protective-tube extension type **NNM-8BS** Adjust the L dimensions by sliding flange

| | | |
|---|--------------------|--------|
| 1 | Paddle | SUS304 |
| 2 | Main Shaft | SUS304 |
| 3 | Sealcap | C3604 |
| 4 | Housing | ADC |
| 5 | Flange | AC |
| 6 | Conduit Connection | G 1/2 |
| 7 | Protective Tube | SUS304 |

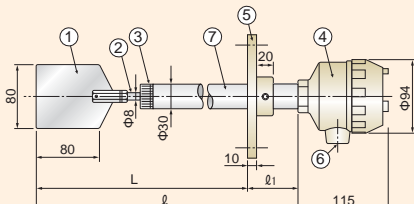
- Flange size: JIS5K65A equivalent
- The L dimensions below flange can be made from over 200mm.
- Heat resistant type can be available.
- Weight: about 2.2kg (L=200)

Heat Resistant Type **NNM-8BH** Operating temperature in a tank: below 180°C

| | | |
|---|--------------------|--------|
| 1 | Paddle | SUS304 |
| 2 | Main Shaft | SUS304 |
| 3 | Sealcap | C3604 |
| 4 | Housing | ADC |
| 5 | Flange | AC |
| 6 | Conduit Connection | G 1/2 |
| 7 | Radiation Fin | ALP |

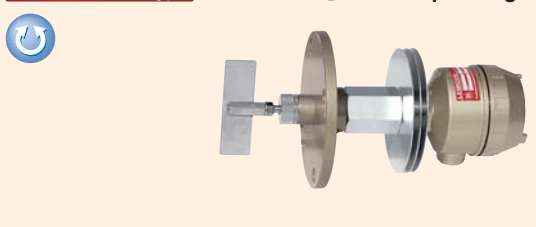
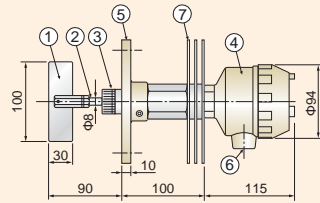
- Flange size: JIS5K65A equivalent
- The L dimensions below flange can be extended up to 200mm.
- Both Shaft-length adjustable and protective tube extension types can be available.
- Weight: about 2.7kg

Diagonal Flange Type **NNM-8BN(S)** Best to mount at the conical area directly.

| | | |
|---|--------------------|--------|
| 1 | Paddle | SUS304 |
| 2 | Main Shaft | SUS304 |
| 3 | Sealcap | C3604 |
| 4 | Housing | ADC |
| 5 | Flange | AC |
| 6 | Conduit Connection | G 1/2 |
| 7 | Protective Tube | SUS304 |

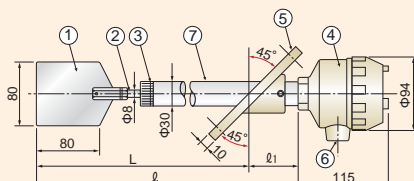
- Flange size: JIS5K65A equivalent
- The standard angle is 45°
- * It is possible to specify the angle.
- Weight: about 2.2kg (L=200)

Paddle Shape

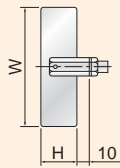

Type A

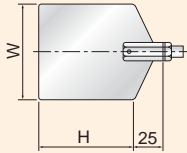

Type B

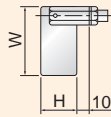

Type C

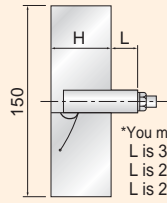

Type D

Special folding paddle

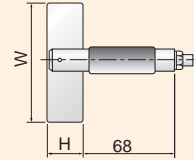

Type F

With flexible shaft

*You may note:
L is 31 when H is 50.
L is 26 when H is 60.
L is 23 when H is 80.

| Paddle No. | W×H (mm) | Shape | when not specified |
|------------|----------|--------------|--|
| 1 | 80×30 | A | 8B, Type-A (100×30) 8BA, Type B (80×80) *NNL/NNM model common spec. |
| 2 | 100×30 | A (Standard) | |
| 3 | 128×25 | A | |
| 4 | 140×30 | A | |
| 5 | 128×80 | A | |
| 6 | 80×80 | B (Standard) | |
| 7 | 128×60 | B | |
| 8 | 60×30 | C (Standard) | |
| 9 | 150×50 | D | |

| No. | Shape | W×H (mm) | Min Specific Gravity |
|-----|-------|----------|----------------------|
| | | | NL Model |
| 1 | A | 80×30 | 2.81 |
| 2 | A | 100×30 | 1.44 |
| 3 | A | 128×25 | 0.83 |
| 4 | A | 140×30 | 0.53 |
| 5 | A | 128×80 | 0.26 |
| 6 | B | 80×80 | 1.06 |
| 7 | B | 128×60 | 0.35 |
| 8 | C | 60×30 | 1.44 |

*In the case of light gravity, products of cross-paddle type or folding-paddle type can be manufactured.
*Paddles other than listed above can be manufactured.
H dimensions of the folding paddle should be 50 as the minimum

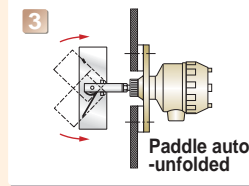
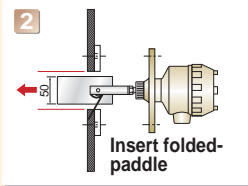
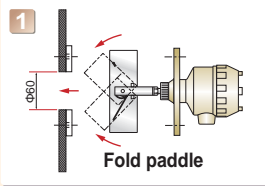

Even if the folding paddle is made larger to measure low-specific gravity products, it can be attached to a tank without any special modifications, depending on the paddle's structure. (Possibly make the bore diameter larger than $\Phi 60$).

L Dimensions Table (Shaft-length Adjustable Type/NL)

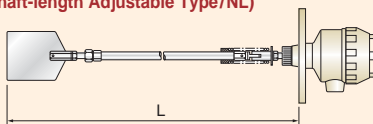

| No. | Max dim.(mm) | Min Dim.(mm) | No. | Max dim.(mm) | Min Dim.(mm) |
|-----|--------------|--------------|-----|--------------|--------------|
| 1 | 500 | 374 | 5 | 2,500 | 1,374 |
| 2 | 1,000 | 624 | 6 | 3,000 | 1,624 |
| 3 | 1,500 | 874 | 7 | 4,000 | 2,124 |
| 4 | 2,000 | 1,124 | 8 | 5,000 | 2,624 |

L Dimensions (Protective-tube Extension Type)

NM-8BS
NNM-8BS

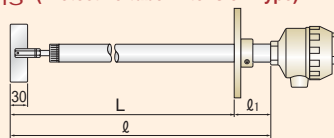

- L dimensions of standard stock are 200, 300, 1000 only.
- About L-dimensions other than listed above, you may use a longer one-by-one size and slide the flange toward the paddle as necessary. Accordingly, ℓ_1 gets longer to the extent.
- When a specific dimension paddle is used, you may slide the flange as described in item 2.
- Products whose length of L is over 1000 may be manufactured upon request.

NM-8BHS
NNM-8BHS

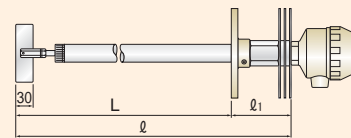

- L dimensions of standard stock are 200, 300, 1000 only.
- About L-dimensions other than listed above, you may use a longer one-by-one size and slide the flange toward the paddle as necessary. Accordingly, ℓ_1 gets longer to the extent.
- When a specific dimension paddle is used, you may slide the flange as described in item 2.
- Products whose length of L is over 1000 may be manufactured upon request.

| Length shape below flange | Paddle shape A 100×30 | | Length shape below flange | Paddle shape B 80×80 | |
|---------------------------|-----------------------|-------------|---------------------------|----------------------|-------------|
| | L | ℓ_1 | | L | ℓ_1 |
| 135~200 (200) | 230 | 230-L (30) | 200~265 (200) | 295 | 295-L (95) |
| 201~300 (300) | 330 | 330-L (30) | 266~365 (300) | 395 | 395-L (95) |
| 301~400 (400) | 430 | 430-L (30) | 366~465 (400) | 495 | 495-L (95) |
| 401~500 (500) | 530 | 530-L (30) | 466~565 (500) | 595 | 595-L (95) |
| 501~600 (600) | 630 | 630-L (30) | 566~665 (600) | 695 | 695-L (95) |
| 601~700 (700) | 730 | 730-L (30) | 666~765 (700) | 795 | 795-L (95) |
| 701~800 (800) | 830 | 830-L (30) | 766~865 (800) | 895 | 895-L (95) |
| 801~900 (900) | 930 | 930-L (30) | 866~965 (900) | 995 | 995-L (95) |
| 901~1000 (1000) | 1030 | 1030-L (30) | 966~1065 (1000) | 1095 | 1095-L (95) |

| Length shape below flange | Paddle shape A 100×30 | | Length shape below flange | Paddle shape B 80×80 | |
|---------------------------|-----------------------|--------------|---------------------------|----------------------|--------------|
| | L | ℓ_1 | | L | ℓ_1 |
| 135~200 (200) | 300 | 300-L (100) | 200~265 (200) | 365 | 365-L (165) |
| 201~300 (300) | 400 | 400-L (100) | 266~365 (300) | 465 | 465-L (165) |
| 301~400 (400) | 500 | 500-L (100) | 366~465 (400) | 565 | 565-L (165) |
| 401~500 (500) | 600 | 600-L (100) | 466~565 (500) | 665 | 665-L (165) |
| 501~600 (600) | 700 | 700-L (100) | 566~665 (600) | 765 | 765-L (165) |
| 601~700 (700) | 800 | 800-L (100) | 666~765 (700) | 865 | 865-L (165) |
| 701~800 (800) | 900 | 900-L (100) | 766~865 (800) | 965 | 965-L (165) |
| 801~900 (900) | 1000 | 1000-L (100) | 866~965 (900) | 1065 | 1065-L (165) |
| 901~1000 (1000) | 1100 | 1100-L (100) | 966~1065 (1000) | 1165 | 1165-L (165) |

Type Designation

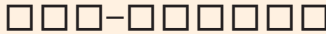

Type of Detection Unit

- S Protective-tube extension type
- F Flexible shaft type
- A Adjustable Shaft Type
- Y Protective cover type
- H Heat resistant type
- N Diagonal flange type

Type of Body

- 8B Main Shaft $\Phi 8$
- 10B Main Shaft $\Phi 10$
- 15B Main Shaft $\Phi 15$
- GM Withstand-pressure explosion-proof, Cable-conduit threaded
- SC Screwed-joint (small hopper) (Shaft $\Phi 8$ or $\Phi 10$)
- DA Inner Tank Hanging Type
(with 5-core cable in 350mm long for external connection)

Name of Series

- NL } Standard Model
- NM } Standard Model
- FL } Explosion-proof
- NNL } Reversible Model
- NNM } Reversible Model

Paddle Mounting

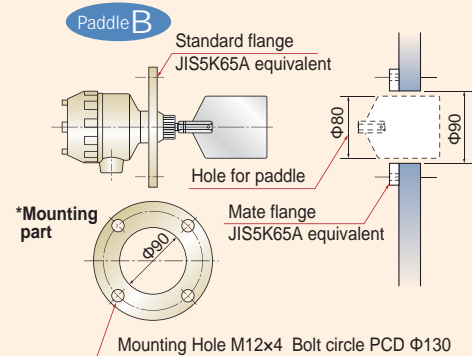
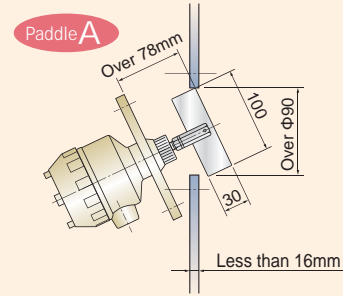

High quality with light weight and high performance at an affordable price!

You can put on a tank without removing the paddle from the unit.
The folding paddle is standard equipment.

Mini Rotary paddle Type Level Switch

LEMICON-S Palm-size



Standard Specification

Power Source : AC100 or 110 or 200 or 220V 50/60Hz
Power Consumption : 1.5W
Contact Capacity : 250VAC 3A (Resistance Load, SPDT)
Rate of Rotation : 0.83r.p.m(50Hz) / 1.00r.p.m(60Hz)
Rotation Direction : Clockwise (Viewing from paddle)
Allowable Temperature : 0~50°C (no freezing) Heat resistant (0~120°C)

Withstand Voltage : 1500VAC one minute
Detection Torque : 170~270N · m x 10⁻⁴
Color : Gold
Setscrew : G 3/4B (material ADC)
Locknut : Hexagonal nut (opposite side 35mm, thickness 10mm, material ADC)
Cable length : 500mm (max)

*Wetted parts made of stainless steel can be available.

Line of business

- Rotary Paddle Type Level Switch
- Vibration Type Level Switch
- Swing Type Level Switch
- Acoustic Level Switch
- Capacitance Type Level Switch
- Capacitive Proximity Sensor
- Capacitance Type Level Indicator
- Diaphragm Type Level Switch
- Tilt Switch
- Leak Type Level Switch
- Microwave Switch
- Sounding Bob Type Level Indicator
- Flow Switch
- Conductance Type Level Switch
- Float Switch
- Float Type Level Indicator
- Ultrasonic Type Level Indicator
- Equipments For Conveyor Lines
- Dust Monitor System
- Zirconia Oxygen Analyzer
- Laser Type Level Indicator
- RADAR Type Level Indicator
- Ultrasonic Flow meter

*Please be sure to read USER'S GUIDE, Installation & Operation Instructions before using the instrument.

*The specifications herein may be subject to change without advance notice.

General Manufacturer of Level Controllers for Powder, Granules, and Liquid

KANSAI Automation Co., Ltd.

Headquarters :
 2-14, Togano-cho, Kita-ku, Osaka 530-0056, Japan
 TEL. 81-6-6312-2071 FAX. 81-6-6314-0848
 e-mail: info@kansai-automation.co.jp

<http://www.kansai-automation.co.jp>

Tokyo Branch : 1-29-6, Hamamatsu-cho, Minato-ku, Tokyo 105-0013, Japan
 TEL. 81-3-5777-6931 FAX. 81-3-5777-6933

Nagoya Office : 3-10-17, Uchiyama, Chigusa-ku, Nagoya 464-0075, Japan
 TEL. 81-52-741-2432 FAX. 81-52-741-1588

Hiroshima Office : 13-11, Noborimachi, Naka-ku, Hiroshima 730-0016, Japan
 TEL. 81-82-222-1555 FAX. 81-82-222-1556

Kyushu Office : 1-1-21, Komemachi, Kokura Kita-ku, Kitakyushu 802-0003, Japan
 TEL. 81-93-511-4741 FAX. 81-93-511-4580

Agent

SCIENCE GATE
 Your Automation Partner



SCIGATE AUTOMATION (S) PTE LTD

No.1 Bukit Batok Street 22 #01-01 Singapore 659592
 Tel: (65) 6561 0488 Fax: (65) 6562 0588
 Email: sales@scigate.com.sg Web: www.scigate.com.sg

Business Hours: Monday - Friday 8.30am - 6.15pm

official site

